

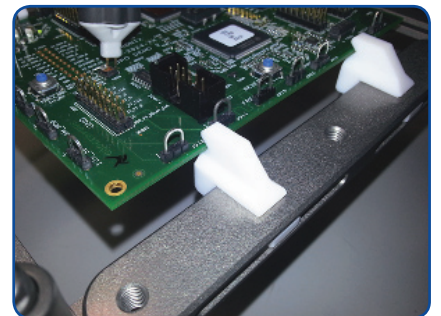

# SKID – PCBA Frame

customer information

- fast and universal setups
- hands free testing
- intuitive clamping system
- testing and debugging
- environmental testing

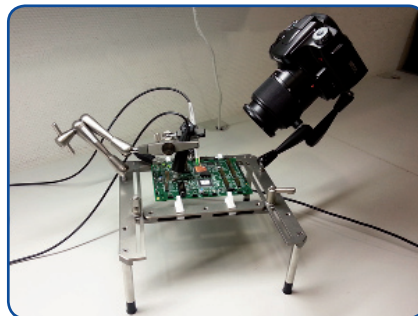
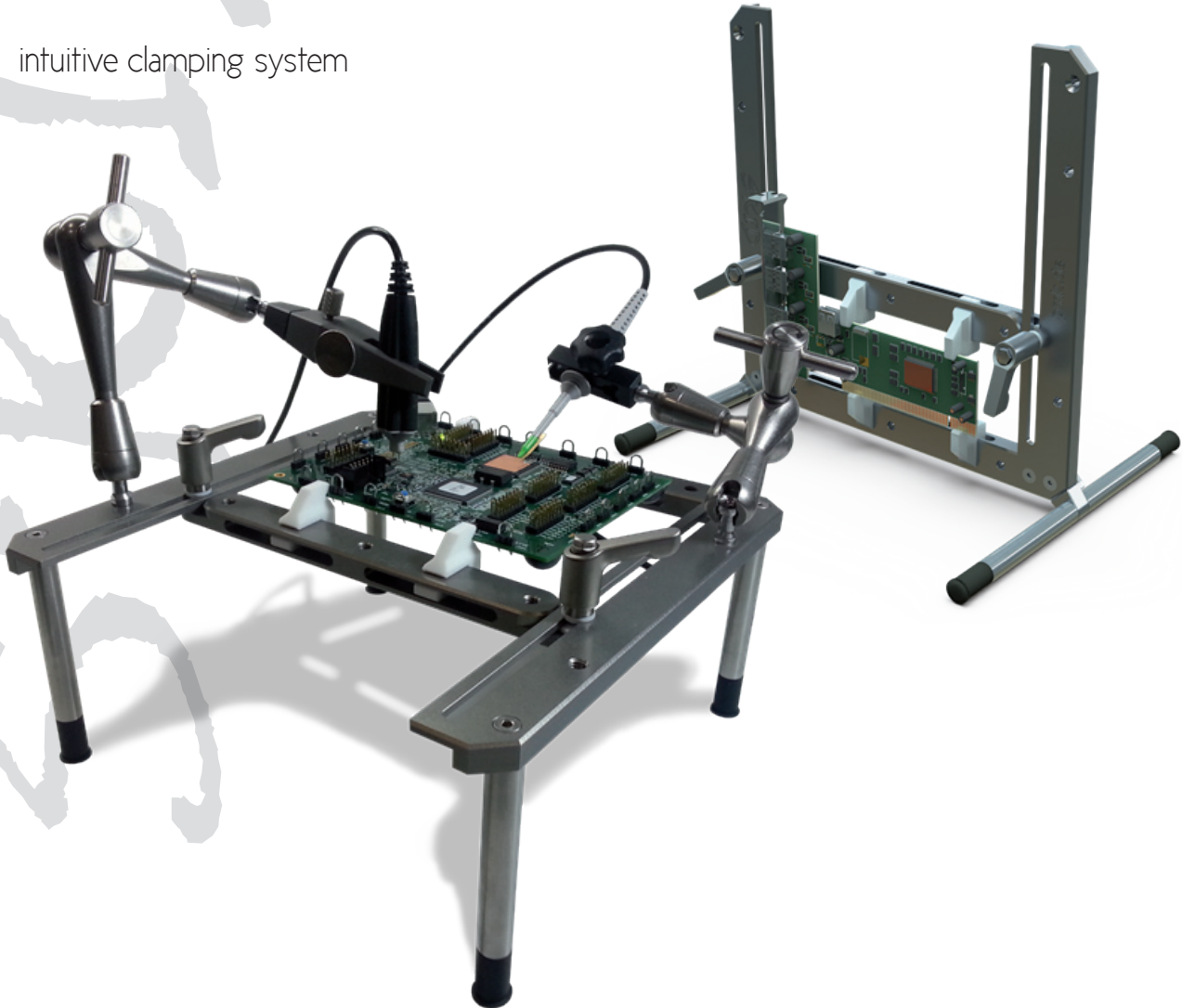

# Easy as it should be

## intuitive clamping system

SKID is a unique platform designed to satisfy all sorts of different demands on PCBA testing and debugging in one single item. It offers a modular design, which enables the user to expand the SKID according to his needs. The frame offers a clamping width of at least 160x160 mm, which fits the 3U standard PCB form factor. Of course smaller boards can be tested as well. The PCBA spacers can be positioned to clamp most geometrical forms; even inconvenient non-standard shapes, that are usually hard to probe.

PROBING SOLUTIONS. MADE IN GERMANY

The PCBA resides 10 mm above the frame, offering a better accessibility to the dut and the SKID itself stands on 90 mm pedestals, enabling access from top- and bottom-side simultaneously. Standard M6 threads are all around the frame to mount equipment, such as probe positioners, lamps or other accessories. Depending on its configuration, Skid can be used for environmental testing in climate chambers for temperatures of -55 to +150 °C .

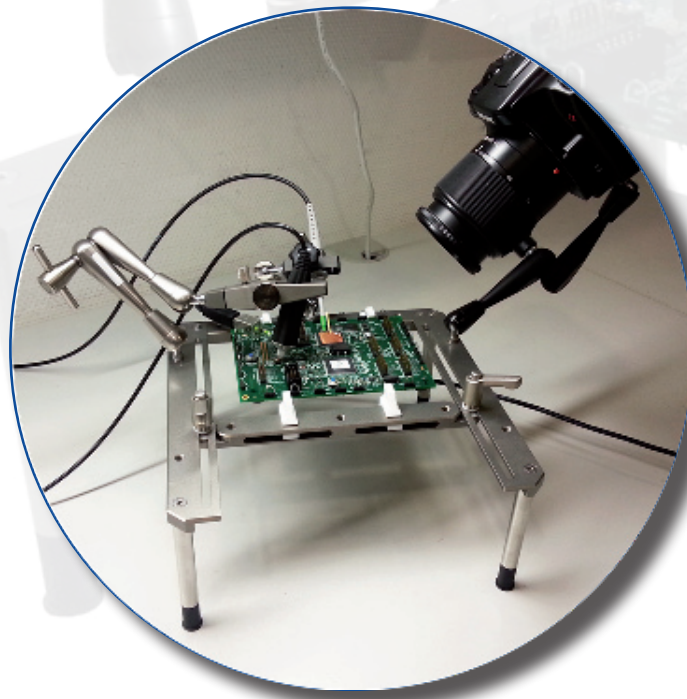

## Fast setups – vast expansion

### modular design for comprehensive adjustments

SKID is available in three sizes. Size S for 3U PCB's, Size M for 6U PCB's and Size L for any PCBA's larger than the 6U standard. Since the frame consists only of a few parts, the setup of the SKID is done in a breath. M6 threads all around the frame allow mounting of multiple accessories, such as test equipment, lighting and magnifiers or even cameras to record or stream video. e.g. thermal images.

The low gravity center of the SKID allows even comparable large and heavy devices to be mounted.

## Low gravity – high friction

The stainless steel pedestals of the SKID are partly coated with rubber to provide necessary friction to the SKID on any surface.

The temperature-resistant rubber withstands temperature ranges from -55° up to 150° C. In combination with the low gravity center of the PCBA frame the pedestals give the SKID a very sturdy stand.

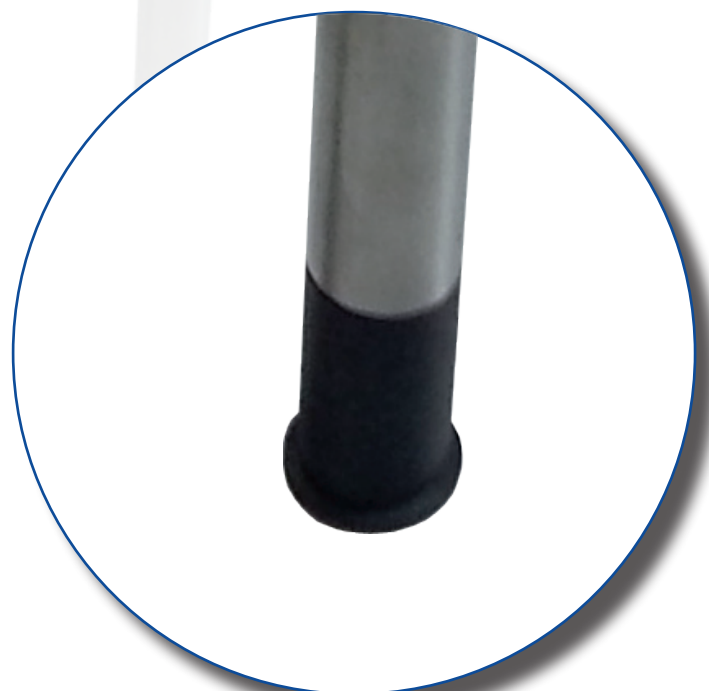

# Intuitive clamping – hands free testing

sliders instead of screws

PROBING SOLUTIONS. MADE IN GERMANY

The release levers of the SKID are designed for single-hand use and slide stageless. PTFE sliders provide smooth movement on the frame surface.

Furthermore the SKID utilizes PCBA spacers, made of PTFE, to give the user the best choice of clamping PCBAs at various positions. Another advantage is the 10 mm gap the spacers provide positioning the PCBA above the frame, offering some additional workspace.

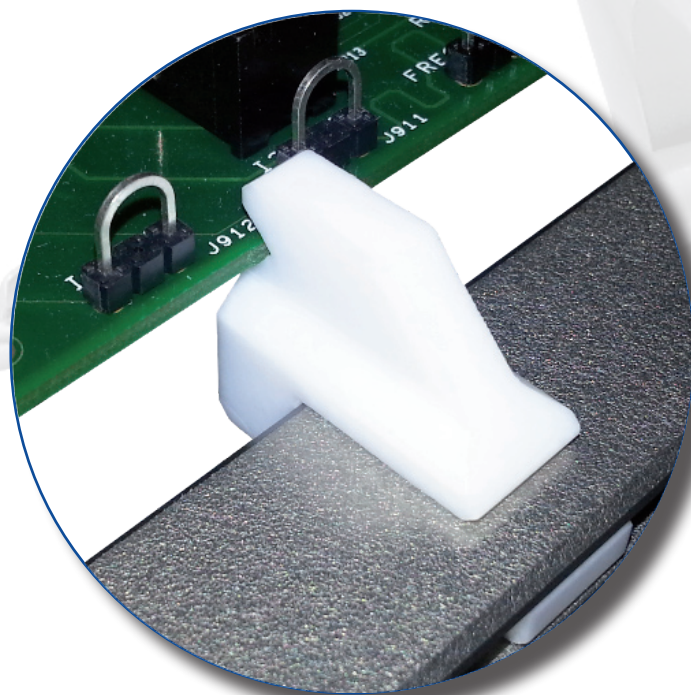

## Mechanical specifications

	Dimensions:	Weight:	Clamping width <sup>1</sup> :
SKID-S	225 x 225 x 100 mm	720 g	160 x 160 mm
SKID-M	305 x 225 x 100 mm	tba	160 x 240 mm
SKID-L	405 x 365 x 190 mm	tba	300 x 340 mm

Materials <sup>2</sup>:

- Frame: aluminium (scratch resistant)
- Pedestals: stainless steel
- Pedestal coating: rubber (temperature resistant)
- Sockets and sliders: PTFE

<sup>1</sup>) PCBAs are positioned above the frame enabling larger PCBAs to be clamped.  
<sup>2</sup>) resistant to temperatures of -50 to +150° C

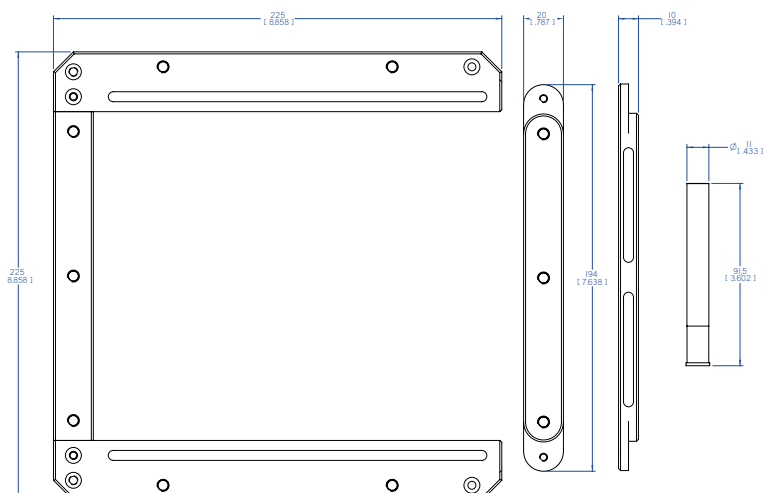

■ 3-Fold Probe Holder (spanwidth 5-12 mm)	893-050-000
■ Uniholder (spanwidth up to 17 mm)	893-090-000
■ PMK 3D Probe Positioner STV 130 <sup>4</sup>	893-200-130
■ PMK 3D Probe Positioner STV 130 V2A <sup>3</sup>	893-200-13V
■ PMK 3D Probe Positioner STV 200 <sup>4</sup>	893-200-200
■ PMK 3D Probe Positioner STV 200 V2A <sup>3</sup>	893-200-20V
■ Camera adapter 1/4" to M6 (AF 13mm)	893-000-M6
■ Release lever V2A <sup>2,3</sup>	016-291-500
■ PCBA spacer (PTFE) <sup>2</sup>	016-292-501
■ Rubber coating for pedestals (-50° to +150° C)	016-292-500
■ Thread adapter M8 to M6 (AF 13 mm)	893-000-M86
■ PTFE slider for release lever <sup>2</sup>	016-292-502
■ Wrench AF 7 mm	893-000-SW7
■ Hex-wrench <sup>2</sup>	893-000-125
■ SKID vertical adapter	016-291-501
■ Pedestal 20 mm	016-291-503

## SKID Models

■ SKID-S (160 x 160 mm)	893-500-000
■ SKID-Starter-Kit (160 x 160 mm)	893-500-START
■ SKID-M (160 x 240 mm)	893-500-010
■ SKID-L (300 x 340 mm)	893-500-020

2) Included in scope of delivery

3) stainless steel build for temperatures of -55 to +150° C

4) standard positioner for temperatures of -40 to +85° C

This datasheet supersedes all previously published material. Specifications that are not marked as guaranteed are published as general information to the user. Note that all information published in this document is subject to change without notice.

## Manufacturer

PMK Mess- und Kommunikationstechnik GmbH  
Königsteiner Str. 98  
65812 Bad Soden am Taunus, Germany

Internet: [www.pmk.de](http://www.pmk.de)

Tel: +49 (0) 6196 5927 - 930

E-Mail: [sales@pmk.de](mailto:sales@pmk.de)

Fax: +49 (0) 6196 5927 - 939

